

INSTRUCTION MANUAL

CONTINUOUS AIR MONITOR (ALPHA & BETA)



TYPE: AM 732AB

NUCLEONIX SYSTEMS PRIVATE LIMITED

Plot No: 162 A & B, Phase II, I.D.A. Cherlapally, Hyderabad - 500 051.
Ph : 91-040-27263701, Fax : 27262146, e-mail : info@nucleonix.com

Document Name : Instruction manual
Date : 10-08-2012

CONTENTS

CHAPTER No.	Title of the contents	Page No.
	Unpacking	
CHAPTER I	Introduction	01-02
CHAPTER II	Technical Specifications	03-08
CHAPTER III	Front panel and Side panel controls / indications	09-11
CHAPTER IV	Block diagram Description	12-21
CHAPTER V	Operating Instruction	22-31
CHAPTER VI	Availing services for Equipment Maintenance/ calibration and warranty clause	32 -34

UNPACKING

Continuous Air Monitor (Alpha/Beta) Type: AM732AB has been thoroughly tested and is dispatched in ready to assemble condition. However, on unpacking and prior to operation, it is advisable to check visually and make sure that there is no visible damage caused in transit. Also checkup the items (instrument / sub-systems/ accessories / cables etc.) physically by verifying with the packing list contents for correct types & quantities. Any discrepancy if found, may please be communicated by email to Head, Customer support division.

Typical packed carton & wooden crates contain

- (a) CAM wired / tested rack with electronic(s) modules plugged-in & miscellaneous items including all connecting cables.
- (b) Suction pump with hardware
- (c) Alpha & Beta suction chambers with PMT& End window detectors mounted.
- (d) Lead shielding for beta suction chamber & other miscellaneous items.

All these items on receiving are to be unpacked carefully & inspected visually.

If any damage to the instrument is observed, do not switch ON the unit and report the matter immediately to:

Head CSD
Customer Support Division
Nucleonix Systems Private Limited
Plot No: 162 A & B, PHASE II,
I.D.A. Cherlapally, Hyderabad - 500 051.

Ph : 91-040-27263701/30918055, FAX : 91-040-27262146, e-mail :info@nucleonix.net

In all correspondence regarding the instrument, please mention the type, serial number of the unit, date of supply etc., of the unit.

CHAPTER - I

INTRODUCTION

Continuous Air Monitor, Type: **AM732AB** manufactured by Nucleonix Systems, designed using state-of-art electronics is primarily used for monitoring Alpha & Beta activity present in the form of suspended particulate in air. It is very much essential to monitor the quality of air in & around Radiochemical plants, reprocessing plants and other similar facilities.

It essentially has an air suction system comprising of a suction pump, rotometers to measure air flow rate, beta suction chamber with arrangement for trapping of suspended dust particulate onto the filter paper. An end window GM tube of 1" dia facing the filter paper counts for Beta activity in CPM /CPS/Bq on continuous basis. Additionally this system has Alpha air-sampler detector assembly consists of a filter holder – 60mm dia, a suction chamber with air inlet and outlet & detector housing fabricated with stainless steel .Alpha Detector consists of ZnS (Ag) deposited on loose mylar support of 50mm dia coupled to matched PMT with Pre-amplifier. Detector Efficiency achieved is of the order of 25% for Plutonium alpha particles over the entire window area. Collection efficiency better than 97% is achieved with this design for both these chambers. Suction chambers design facilitates the user to easily replace the filter paper(s) periodically as per the requirement.

Electronic modules built-in will indicate, the air sample activity deposited on the filter paper in terms of CPM/ CPS/ Bq .Other electronic sub-systems built-in include HV module, SMPS, controller card, EMI/EMC filters current loop circuit, relay & relay driver circuit etc .Front panel has 16X2 LCD dot matrix display,6-digit 7 segment display, alarms indicating cluster LED displays ,audio buzzer,9-pin D-connector to facilitate connection to external key pad etc. Rear panel has connectors for connecting to Alpha probe, Beta probe, test socket, 17 pin I/O connector, test sockets, 9-pin D-connectors for RS485 in/out, A.C. mains switch, fuse holder etc. This module will provide alarm annunciation both visual and aural when the activity exceeds preset level. This system provides current loop output; relay output on 17 pin I/O connector. RS485 IN/OUT ports facilitate connection to SCADA for data communication for visualization of CAM parameters. In respect of AM732AB two electronic modules are used, one configured for monitoring of Alpha particulate activity and the other for monitoring of Beta particulate activity.

Features:

- State-of-art electronics design using controllers with embedded code, I²C, micro-wire bus based devices makes the equipment compact and highly reliable.
- End window GM tube GM 125 is used as Beta detector. Efficiency achieved is better than 30% with Sr-90 Beta.
- Loose Mylar ZnS (Ag) scintillator screen coupled to 2" PMT is used as Alpha detector. Efficiency for Am-241 alpha is better than 25%.
- Collection η for both chambers is better than 97%.
- 16x2 LCD display is used for display of count-rate status and other information.
- Detachable hand-held keypad for configuration of the instrument.
- RS-485 built-in for remote monitoring and diagnostics.
- 4-20mA current loop o/p for full-scale range of each channel.
- Count-rate display additionally provided on SIX-digit SEVEN-segment display.

**Fig (1) CONTINUOUS AIR MONITOR
TYPE: AM732AB**



CHAPTER – II

TECHNICAL SPECIFICATIONS

The Dual Channel Continuous air monitor (Alpha & Beta) is designed to monitor airborne releases of alpha-emitting and beta emitting radio nuclides. The instrument will comprise a common vacuum pump, two sets of air sampler cum detector assembly and an electronic unit. The detectors will be of ZnS (Ag) Scintillation detector & Halogen quenched end window GM detector. The electronic unit comprises of two channels of low voltage supplies, High voltage supply, Pre-amplifier & Amplifier, Count rate meter and Alarm generation module. The electronic unit and the detector assemblies are mounted inside a single floor mounted trolley.

(A) Air-Sampler cum Detector Assembly (Alpha):

The air sampler cum detector assembly for alpha consists of a filter holder 60mm dia., a suction chamber with two nozzles (air inlet and outlet) of size ¼” serrated and detector housing.

Air samplers are fabricated with stainless steel SS 304L. Air sampler is designed and fabricated to achieve the particle collection efficiency better than 99% for air particles down to 0.3 micron size on glass filter paper.

The Detector assembly for Alpha monitoring has the following specifications:-

- Detector and size: ZnS (Ag) phosphor, 50mm dia coupled to a matched photo-multiplier with pre amplifier.
- Window Thickness: 1.5 mg/cm² light-sensitive pin-hole free aluminized mylar with protection against puncture.
- Detector Efficiency: Not less than 25% for plutonium alpha particles over the entire window area.

(B) Air-Sampler cum Detector Assembly (Beta):

The air sampler cum detector assembly for beta consists of a filter holder 60mm dia., a suction chamber with two nozzles (air inlet and outlet) of size ¼” serrated and detector housing.

Air samplers are fabricated with stainless steel SS 304L. Air samplers are designed and fabricated to achieve the particle collection efficiency better than 99% for air particles down to 0.3 micron size on glass filter paper.

The assembly is to be shielded by 50mm of lead in a manner that provides easy access for loading and unloading of the filter paper and removal of detector. The lead assembly will be designed with proper care to avoid any injury to the technicians while opening and closing the assembly.

The Detector assembly for Beta monitoring will have the following specifications:-

- Halogen-quenched end-window G.M. Counter
- Type : LND - 72314 or equivalent
- Window : 1.5 - 2.0 mg/cm², mica, effective dia. 39 mm.
- Wall thickness : 1.5 mm
- Effective length : 36.25 mm.
- Effective dia : 28.12 mm
- Material : 446 SS
- Max. tube dia. : 33.0 mm.
- Max. Overall length : 52.50 mm

- Operating voltage range : 450-750 V.
- Operating voltage : 500V
- Beta efficiency response : Upto 4 Mev
- Gamma energy : 0.3 MeV to 1.5 MeV

(C) Suction / Vacuum system:

This Suction / Vacuum system provides the required suction for drawing air through the filter paper in the air sampler assembly. The system will comprise a Dry type, noise-free, continuous duty, pump-motor set.

Vacuum pump-motor set:

- Free air displacement : 150 liters/min (Min.)
- Ultimate vacuum : 550 mm Abs (22" Hg)
- Pressure : 1.4 Kgs/cm² (20 lbs)
- Duty : Continuous.
- Electric Motor : ½ HP, 1440 RPM with gear box, 220/230V AC, capacitor start, single phase TEFC B-56 frame, Class "B" insulation, continuous rating Crompton or equivalent.
- Vanes : Made of self lubricant special H17 grade graphite.
- Bearings : Sealed ball bearings.
- Mountings : Pump and motor mounting is on a common base plate.
- Drive : "V" belt and pulley driven (belt covered by belt guard)
- Air inlet/outlet : ¼" serrated nozzles.
- Vibration : suitable anti-vibration pad.
- Silencer : The pump should be provided with a silencer to give a noise free operation.
- Pump failure alarm : Pump failure alarm indication is provided on the instrument and the same is wired on the remote console.
- Make : The pump is of M/s Tawde make or equivalent.

(D) Flow measurement and regulation:

- The instrument has two sets of Air rotameter 50- 200 lpm. with ¼" serrated SS nozzles for connection to 12 mm ID PVC tubing.
- Rotameters are mounted in a tamper-proof manner in the air sampling line.
- One rotameter will be connected to the air sampler for Alpha and the other to the air sampler for beta.
- Provision is given to discharge the hot air from the vacuum pump

(E) Electronic Unit: Qty 2 Nos.

Each electronic Unit will comprise of single channel of Low voltage power supplies, EHT supply, pre-amplifier, count-rate meter based on microcontroller and audio visual alarm system will be provided for the two detectors.

Low Voltage power supply : Independent low voltage power supplies supply the DC power supplies required for the operation of each channel of electronic module. They have a very good line voltage and load regulation. The modules are be fitted with Mains line filters to avoid line interferences.

EHT Supply : Single channel EHT voltage module is provided for the working of either the GM detector or Photomultiplier tube. The output voltage of each channel will be continuously variable from +100V to +1200V independently. Output will be adjustable by screwdriver and EHT can be

shown on the display using the detachable keypad.

Pre-amplifier : Single channel Pre-amplifier module compatible with the GM detector & ZnS Scintillation detector is provided in the unit. It will provide the amplification and shaping for the pulse signals from the detectors. The output of the amplifier will be given to the Count rate meter for further data processing and display.

Count-rate meter : The count rate meter is provided for processing the data from the corresponding detector and display the same. Important features of the countrate meter are listed below.

- Unit : CPM / CPS / Bq
- Ranges : 0 - 50000 CPM (or) 0 – 2000 CPS (or) 0 - 50000 Bq, with provision for unit selection and range adjustment.
- Time Constant : Between 60 to 1 sec automatically varying inversely with count-rate through out the range.
- Display : Auto Ranging direct reading, 6 digit 7 segment LED display & 16x2 LCD display. 6x7 LED display is interfaced using multiplexed display driver and is used for display of count-rate and hardware status indication & 16x2 LCD for visualization of preset alarm and other parameters
- Display updating :
 - First reading on Power ON within 12 secs.
 - Normal (Slow) : 60 sec to 12 sec automatically varying inversely with the radiation level.
 - Abrupt detection : Update the current reading within 1 sec and return to normal mode.
- Overload : Senses overload above 200% of full-scale and indicates on display “OL”
- Over-range : Senses if the radiation field being measured has exceeded the measurement range of the instrument and upto 200% of the instrument and displays “OFI”.
- Recorder output : 4 to 20 mA, with 600 ohm load.

Recorder output stability

- (a) Non-linearity : Max = 0.025% of Span
- (b) Offset current ($I_o=4mA$) : Max = 0.0005% of Span / °C
- (c) Span Error ($I_o=20mA$) : Max = 0.005% of Span / °C

- Accuracy : +/- 5% Full scale.
- Calibration Accuracy : +/- 5% through out the range.
- Testing Facilities : Provision to inject a suitable pulse generator signal for routine testing of Count rate meter will be provided on the rear panel.
Additionally a test pulse mode through software for checking count-rate meter will be provided
- Instrument “ON” Indication : Large Area Green LED Lamp. This will indicate the Normal condition also.

Audio Visual Alarm system:

The instrument is provided with two sets of alarm circuits with independent LEDs for Normal operation, Alarm etc. Two sets alarm relays will be provided.

- Alarm range : 1 to full scale reading
- Alarm setting : The alarm level setting will be carried out through RS-485 serial port with handheld configurator / PC with password protection.
- Alarm Indication : a) Red (LED) flashing large area window display
b) Loud audio tone (single / dual frequency tones)

Alarm annunciation scheme: As tabulated below;

<u>Parameter Status</u>	<u>Visual indication (Red LED)</u>	<u>Audio</u>
Normal	OFF	OFF
Abnormal	Flashing	ON
On Acknowledgement	Steady Red	OFF
Back to Normal	Steady Red	OFF
Reset on abnormal	Steady Red	OFF
Reset on normal	OFF	OFF

Instrument Controls:

- a) Acknowledgement switch for muting audio
- b) Reset switch for resetting the Alarm indication and alarm relay.
- c) Power ON/OFF switch with Power ON indication
- d) EHT ON/OFF switch is provided on the front panel

Instrument Fault indication:

- a) EHT failure: Visual alarm with flashing red LED indication & “Eht” message on display
- b) Detector failure: Visual alarm with flashing red LED & “d-FI” message on display.
- c) Microprocessor / microcontroller failure: Visual alarm with flashing green lamp.
- d) Fault indications are cleared automatically if normal status is resumed.

Housing : All the modules of the Electronic unit will be housed in rack mounted type cabinet . The modules are plug in type and all the controls and display are available on the front panel. The enclosure will comply with IP-21.

Remote /External Console:

The instrument is provided with two remote console connectors for the two channels.

- 4 - 20 mA linear proportional to full scale display output. Current output will be able to drive load of 600 ohms. Output circuitry will be able to drive 200 mtrs. of twisted pair of wires.
- Two sets of potential free contacts of Alarm relay (Change over). Contact rating 3 Amp at 250 VAC. The relay will be energized on normal condition and de-energised under alarm condition.
- Remote alarm acknowledgement and reset signals for the field instruments.
- Indication of instrument fault condition (detector, EHT & LV supplies failure), over range & overload conditions by up-scale or 4-20 mA. (22.5 mA)
- Pump failure alarm contact.
- All these signals will be terminated on 17 pin sockets (Allied Connectors). The corresponding mating plug with 5 mtr cable will be supplied with the monitor.
- RS-485 serial port. This will be in parallel with D-type connectors.

Computer Interface:

Each channel of the instrument has a RS-485 Serial Communication port for interfacing with a IBM PC-compatible computer. The PC and the monitor will operate in a host-slave configuration in a multi-drop network through this interface. The PC as the host will give commands and send queries. The monitor will carry out the various functions as per the required information in response to the queries.

The firmware of the monitor will be able to send the instrument data like Instrument ID, Instrument type, Input range, Display range, alarm settings, alarm status, current reading, diagnostic status of EHT/GM tube etc. to the Host PC on demand. The firmware will be able to receive commands from Host PC and carry out the setting of different parameters like Instrument ID, Instrument type, Input range, Display range, alarm settings, Ack, Reset, EHT setting, instrument address etc. The configuration settings will be password protected and the password will be user defined.

The detailed specifications for the interface will be as follows:

Type	:	RS-485 Multidrop Serial Communication Port, Half Duplex Bi-directional communication.
Character Format	:	ASCII
Protocol	:	Modbus / RTU.
Bit Rate	:	User configurable to 9600 or 19200 bits per sec.
Address	:	User configurable from 0 to 255.
Connector	:	9-pin D-type connectors (2 connectors connected in parallel for daisy chaining a number of instruments). The mating connectors with cover will be supplied.

Self Diagnostics:

The monitor has built-in self diagnostics. On being powered it will perform tests to ensure that all components and sub systems are functioning properly. It will check for the Power supply, High Voltage Supply, Detector, Counting and measuring circuits, Alarm Systems and Display Systems.

The firmware will not halt monitoring / data acquisition function any time. The firmware is designed for high reliability and availability.

Test points are provided for checking the EHT voltage and for connecting external input pulse signals.

Input Power:

230VAC +/-10%, 50Hz, single phase supply. Power ON/OFF indication will be provided with an indicator LED. Spike suppressor and line filter are provided.

Environment:

The instrument is designed to be able to withstand temperature up to 50 deg C and relative humidity upto 90% in radiation areas.

Environmental compliance : As per IS 9000 / ANSI N 42.17

The instrument enclosure and detector assembly will comply with IP-21. Electronic units will withstand cumulative radiation dose of 10000 Rad. (30 years of operation).

EMI / EMC compliance: As per IEC 61000 / ANSI N42.17

Mechanical Dimensions (overall) :

Size : Height : 1500mm Width : 650mm Depth : 480mm

Instrument Trolley:

- All the hardware like Vacuum pump, Air sampler & detector assembly, lead shielding, rotameters, Electronic unit etc may be fitted in an Instrument trolley made of M.S.
- The trolley will be provided with castor wheels with locks / breaks.
- The trolley is powder coated with DA Grey colour.
- Front and Rear sides will have doors with magnetic lock.
- The vacuum pump is fitted at the bottom with guards & shock absorbers.
- Pump discharge (hot air) will go out of cabinet.
- Two Mains supply boards with required sockets, indicators and switches / MCBs will be provided inside the trolley.
- One power board will be used for Vacuum pump and the other will be used for electronic unit.
- Internal PVC tubing will be done between Suction head, rotameter, pump etc.

CHAPTER - III FRONT & REAR PANEL CONTROLS & INDICATIONS

3.1. GENERAL

Continuous Air Monitor AM732AB mechanical structural unit essentially consists of a Rack with castor wheels, having three compartments with hinged door arrangement. Top compartment encloses two identical electronic modules. One module is configured to measure Alpha particulate activity & the other module is configured to measure Beta particulate activity.

Second & third compartments with hinged door arrangement houses Beta and Alpha suction air samplers with respective Rotometers. Bottom most compartment houses suction pump. This pump is a dry vane pump used for continuous operation. Front face of this rack is covered by three hinged doors.

The following paragraphs describe control / indicators on electronic module. For continuous Air monitor AM732AB two identical modules are used. The only difference being one module is configured & connected to Beta suction chamber & the other to Alpha suction chamber.

3.2 FRONT PANE CONTROL, DISPLAYS & INDICATION

Front Panel of each Electronic unit consists of various displays, indicators & controls. They are as listed below.

- i. LCD Display: 16x2 dot-matrix display, status display configure parameters
- ii. 6-digit 7 segment display: Current countrate from alpha & beta channels are displayed on 6 digit 7 segment displays. Additionally it will show fault diagnostics parameters failure, flow / pump failure. LV failure etc.,
- iii. Indicators :1 set of RED & GREEN bar LEDs have been provided to indicate the alarm status of each of the channels and 3 yellow LED's have been provide for to indicate mode of collection, CPS, CPM and Bq.
- iv. ACK & RESET Buttons : Two push button switches are provided for acknowledging and resetting the unit during active mode.
- v. Keypad connector: This keypad connector (9-pins D) facilitates connection to keypad through cable.
- vi. Keypad: It comprises of 4 keys. Once programmed keypad can be detached and kept safely. It is used to configure the instrument settings initially.

PROG ► : This is used to select and view the next program operation in the program menu.

PROG ◀ : This is used to select and view the previous operation in the program menu.

INC ▲ : This key is used to increment the value of the number at current location or to toggle parameters.

DEC ▼ : This key is used to decrement the value of the number at current location or scroll the cursor to left of a number or to toggle a parameter.

- vii. Audio (Buzzer) : This audio buzzer is fixed on to the front panel.

REAR PANEL CONTROLS

Rear panel consists of various types of connectors & switches.

- i. Mains socket : This is a THREE-pin MS connector (Male) for connecting the power cord.
- ii. Fuse holder : It holds a 1.5 mA fuse provided for short circuit protection.
- iii. ON Main ON/OFF toggle switch : A toggle switch provided on the rear panel, which is used to POWER the unit. When the switch is put ON, the mains AC is made available to the unit.
- iv. RS-485 IN and RS485 OUT: These are 9 pin D-connectors (Female and Male) used for RS485 connectivity of Instrument to PC
- v. Alpha probe (MHV socket) : It is a MHV socket used for providing biasing voltage to alpha scintillation detector (if electronic module is configured for Alpha counting)
- vi. Beta probe (MHV socket) : It is a MHV socket used for providing biasing voltage to LND-72314 (if electronic module is configured for Beta counting)
- vii. HV (0-1200V) Test Point (MHV socket) : It is a MHV socket used for checking the high voltage for Alpha/Beta probe.
- viii. HV (0-1200V) Trimpot : It is a variable trimpot used for adjusting HV (externally with the help of trimmer) from 0-1200V on rear panel of the module.
- ix. 17 pin I/O connector : This is a 17pin MS connector used for providing Relay contact signals & current loop, & RS485 signals.
- x. Flow sensor 3 pin socket : It is an 3 pin I/O used for taking flow sensor signals
- xi. Test points sockets : Test points provided for checking 12V, 24V, 5V, GND
- xii. Test input (BNC) : This is applicable for electronic modules configured for alpha & beta. This facilitates one to inject external tail pulse input for checking the functionality of the module. This is a single BNC input.



Fig (2) ELECTRONIC UNIT FRONT VIEW



Fig (3) ELECTRONIC UNIT REAR VIEW (identical for Beta & Alpha channels)

CHAPTER – IV

BLOCK DIAGRAM DESCRIPTION

Continuous Air Monitor AM732AB is described & illustrated through three block diagrams, namely

- A. Particulate collection & suction system block diagram
 - B. Alpha particulate detection & measurement system block diagram
 - C. Beta particulate detection & measurement system block diagram
- Additionally this chapter includes
- D. Electronic Module Interconnections and
 - E. Wiring Diagrams Description also

This above method is followed primarily for better understanding of the system.

A. PARTICULATE COLLECTION & SUCTION SYSTEM BLOCK DIAGRAM

Firstly the focus will be on the description of 'particulate collection & suction system', through its block diagram fig (4).

This system consists of suction pump, Alpha, Beta, Collection chambers with particulate detectors, rotameters & PVC tubing, with flow rate control needle valves etc. Continuous Air Monitor AM732AB is installed either at a location where the atmospheric air is to be let in or connected to stack by-pass for continuous monitoring of particulate activity for Alpha & Beta. Once the suction pump is made ON, air is drawn through two separate inlets (for alpha & beta) into collection chambers where the suspended particulate gets deposited onto filter paper. Further this air passes through respective rotameters, T-junction, pump & either to atmosphere or back into stack, where from it would have been drawn, in case of stack monitoring. Block diagram fig (4) indicates clearly by arrow marks air flow path from different sub-systems.

Air suction diagram indicated in figure-(4) illustrates the components involved, that make-up the system.

Suspended air particulate gets deposited on filter paper as it passes through respective suction chambers. The beta detector (End window G.M. tube) inside the suction chamber facing the deposited air particulate on filter paper, records Beta activity in CPS/CPM/Bq. Similarly Alpha detector (Zns screen coupled to PMT) facing the deposited air particulate on filter paper, records alpha activity in CPS/CPM/Bq.

Both the suction chambers facilitate opening, for changing filter paper periodically. Also Beta suction chamber is surrounded by 1" lead shielding all around the detector.

Air enters from these chambers into respective rotameters which indicate the air flow rate. The output from these rotameters enter a "T" – junction & it gets connected to a flexible pipe to the vacuum pump & then air is let out into the atmosphere back to stack.

Each of the rotameters has IR Led- source and-sensor arrangement placed across float. This is used to sense and indicate flow rate failure /pump failure to the user.

**FIG (4) : PARTICULATE COLLECTION & SUCTION SYSTEM BLOCK DIAGRAM
(FOR CAM AM732AB)**

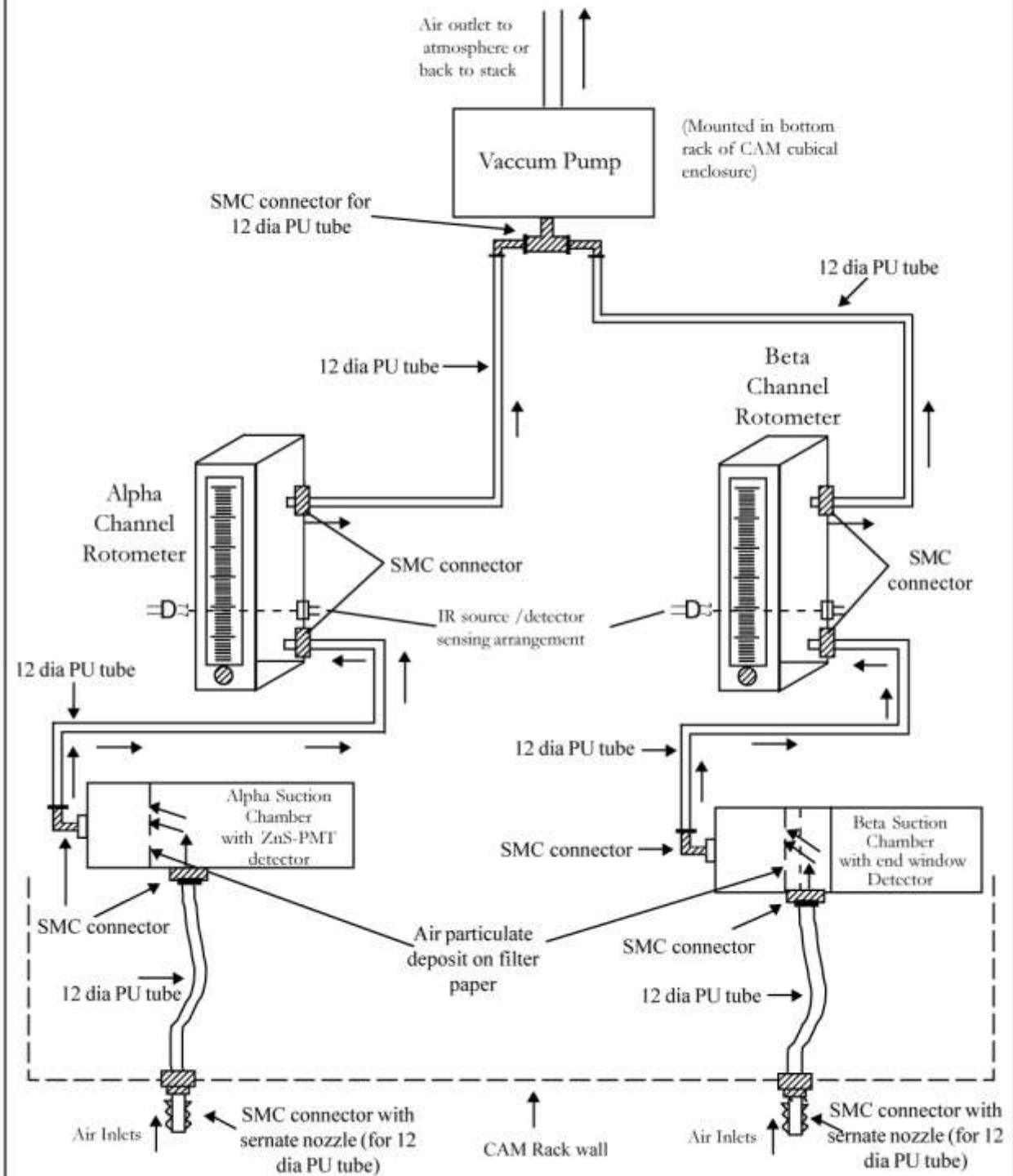

B. ALPHA PARTICULATE DETECTION & MEASUREMENT SYSTEM BLOCK DIAGRAM

The following paragraphs are to be read by referring to the block diagram fig (6) enclosed.

This block diagram illustrates complete Alpha particulate detection & measurement system including electronics sub-systems used.

Alpha suction chamber: In the front end one can notice that a ZnS screen coupled to PMT enclosed in a suction chamber serves as the detector for the Alpha particulate that are allowed to get deposited on a filter paper positioned closely in front of this ZnS screen. Scintillations produced on ZnS-PMT due to Alpha particles, generate negative tail pulses. They are converted to TTL pulses in the Tail to TTL converter pre-amplifier. There follows, a 4 channel analog switch through which these detector pulses are passed into an 8 digit counter which is interfaced through I2C bus to micro-controller chip.

Under program control this microcontroller reads the counts from 8 digit counter & displays on LCD & LED displays in the unit (CPS /CPM/Bq) chosen. Analog MUX chip allows either alpha or G.M (Beta) or test pulses into the counter, depending on the mode selected.

SMPS module : This is integral part of the electronic module which provides +5V @ 4A, +24V @ 1A & +12V @ 0.5V to all electronic circuits within the module.

HV module: This receives LV supplies from SMPS & generates 900V @ 0.5mA which is used to bias PMT. It generates stable HV with low ripple & good regulation. Of course HV module output is adjustable from (10-1200V) @0.5mA & can be set to a particular voltage depending upon the type of detector used.

4 channel ADC: This receives fraction of EHT, +12V & +24V which are read by ADC, under program control. Failure of EHT, +12V & +24V supplies is indicated on LED display to the user.

Microcontroller & associated peripheral devices : Heart of the electronics is microcontroller with embedded code & associated peripheral chips. Under program control these circuits provide, user interface through external keypad & other command buttons such as alarm ACK & RESET. Also they facilitate user to program for the selection of desired data acquisition mode & provide output on visual displays (LED / LCD) & other status LEDs. Additionally it provide port control to drive relays, facilitate RS485 communication etc.,

6 digit 7 segment LED display: It can be seen from the block diagram that it provides 6 digit seven segment displays through, multiplexed driver chips to show-up air activity in CPS/CPM/Bq & hardware status.

16x2 LCD dot-matrix display: is interfaced through I/O expander to controller through I2C bus drives to display programmable parameters & facilitate the user to set these values, etc.,

Buzzer: Through a microcontroller port buzzer is controlled. This buzzer driver circuit is designed to produce dual tone.

Visual alarms, namely ACTIVE LED indication & Units indication LEDs and ACK/RESET function buttons: All these are interfaced through an I/O expander & connected to microcontroller through I2C bus.

Visual alarm ACTIVE LED indication: is lit whenever, there is alarm condition, on exceeding of preset level.

ACK push button: This when pressed on alarm condition, audio goes mute & visual alarms remain active.

Reset button: This when pressed resets both audio & visual alarms if the dose rate goes below the preset level.

External keypad (detachable): Through another I/O expander, keypad is interfaced for programming / configuring various options for Continuous Air Monitor functionality. These functions include EHT, PROG, INC, DEC, command buttons.

Current loop / (0-5V) output: From the block diagram it can be noticed that a precision 14 bit serial DAC generates analog output proportional to the count rate (unit selected CPS/CPM/Bq). This after amplification generates (0-5V) output which is made available on 17 pin I/O connector. Further same signal goes to voltage to current loop converter to generate (4-20mA) output which is also made available on the 17 pin I/O connector.

Relay contacts output: Relay contact activation is made (a) under alarms condition & (b) under hardware failure condition. Under ACTIVE alarm condition two sets of relay contacts are made available on 17 pin I/O connector, which are normally in energized condition .with no alarm condition they get de-energized.

Another relay contact is made available to indicate hardware failure of (LV& HV)

NORMAL cluster LED display: This is controlled & lit through microcontroller port & through watch dog timer, control. This is used to show-up NORMAL status i.e., no alarm condition. Also it blink continuously in microcontroller failure condition.

RS485 through opto isolator: This part of the block gets activated for data communication into network through SCADA. One can program & have complete visualization of all the systems parameters in the network through SCADA. Through opto isolator & RS485 converter chip data is terminated on 9-pin D-type connector pair (male/female) for daisy chaining.

E²PROM: Memory stores program parameters, preset limits, data values & is interfaced to microcontroller through I2C bus.

Flow sensor: This part of the circuit is used to sense Rotometer float (SS) level, using IR LED & diode detector in the path. Output from this circuit is connected to a port of microcontroller which senses level change when there is change in flow rate or pump failure. This failure is indicated on 6 digit 7 segment displays.

Test input (BNC socket) : This is provided on rear panel of the module to inject –ve tail pulse from a tail pulse generator into the electronic module for pulse calibration and functional testing of the unit.

C. BETA PARTICULATE DETECTION & MEASUREMENT SYSTEM BLOCK DIAGRAM

The following paragraphs are to be read by referring to fig (5) which shows the detailed block diagram of Beta particulate activity monitoring system, on continuous basis. It can be seen from the block diagram that beta particulate air activity monitor consists of a beta suction chamber, lead shielding to reduce background counts, suction pump, rotometer & an electronic module.

In this suction chamber, air particulate is deposited on a filter paper as the suction pump is turned ON. Wide end window G.M tube facing, close to the filter paper counts beta activity present on the filter paper continuously. Beta suction chamber has G.M. detector enclosed inside. This chamber is covered all around with a 50mm lead shielding to minimize background.

SMPS module: This is an integral part of the electronic module which provides +5V @ 4A, +24V @ 1A & +12V @ 0.5V to all electronic circuits within the module.

HV module: HV module which is integral part of the electronic unit, draws +12V & +12V from SMPS & generates +500V @ 0.5mA. This is used to bias end window G.M detector.

Tail to TTL converter: This is essentially a charge sensitive pre-amplifier with built-in comparator & mono which converts, these tail pulses to TTL pulses.

4 channel ADC: This receives fraction of EHT, +12V & +24V which are read by ADC, under program control. Failure of EHT, +12V & +24V supplies is indicated LED display to the user.

Microcontroller & associated peripheral devices: Heart of the electronics is microcontroller with embedded code & associated peripheral chips. Under program control these circuits provide, user interface through external keypad & other command buttons such as alarm ACK & RESET. Also they facilitate user to program for the selection of desired data acquisition mode & provide output on visual displays (LED / LCD) & other status LEDs. Additionally it provide port control to drive relays, facilitate RS485 communication etc.,

6 digit 7 segment LEDs display: It can be seen from the block diagram that it provides 6 digit seven segment displays through, multiplexed driver chips to show-up air activity in CPS/CPM/Bq & hardware status.

16x2 LCD dot-matrix display : is interfaced through I/O expander & to controller through I2C bus drives to display programmable parameters & facilitate the user to set these values, etc.,

Buzzer: Through a microcontroller port buzzer is controlled. This buzzer driver circuit is designed to produce dual tone.

Visual alarms / namely ACTIVE LED indication & Units indication LEDs and ACK/RESET function buttons : All these are interfaced through an I/O expander & connected to microcontroller through I2C bus.

Visual alarm ACTIVE LED indication: is lit whenever, there alarm condition on exceeding of preset level.

ACK push button: This when pressed on alarm condition, audio goes mute & visual alarms remain active.

Reset button: This when pressed resets both audio & visual alarms if the dose rate goes below the preset level.

External keypad: Through another I/O expander keypad (detachable) is interfaced for programming / configuring various options for Continuous Air Monitor functionality. These functions include EHT, PROG, INC, DEC.

Current loop / (0-5V) output: From the block diagram it can be noticed that a precision 14 bit serial DAC generate analog output proportional to the countrate (unit selected CPS/CPM/Bq). This after amplification generates (0-5V) output which is made available on 17 pin I/O connector. Further same signal goes to voltage to current loop converter to generate (4-20mA) output which is also made available on the 17 pin I/O connector.

Relay contacts output: Relay contact activation is made (a) under alarms condition & (b) under hardware failure condition. Under ACTIVE alarm condition two sets of relay contacts are made available on 17 pin I/O connector. Which are normally in energized condition, with no alarm condition & get de-energized on alarm condition.

Another relay contact is made available to indicate hardware failure (LV, HV)

NORMAL cluster LED display: This is controlled & lit through microcontroller port & through watch dog timer, control. This is used to show-up NORMAL status i.e., no alarm condition. Also it blink continuously in microcontroller failure condition.

RS485 through opto isolator: This part of the block gets activated for data communication into network & through SCADA. One can program & have complete visualization of all the systems parameters in the network through SCADA. Through opto isolator & RS485 converter chip data is terminated on 9-pin D-type connector pair (male/female) for daisy chaining.

E²PROM: Memory stores program parameters, preset limits, data values & is interfaced to microcontroller through I2C bus.

Flow sensor: This part of the circuit is used to sense Rotometer float (SS) level, using IR LED & diode detector in the path. Output from this circuit is connected to a port of microcontroller which senses level change when there is flow rate or pump failure. This failure is indicated on 6 digit 7 segment displays.

Test input (BNC socket) : This is provided on rear panel of the module to inject –ve tail pulse from a tail pulse generator into the electronic module for pulse calibration and functional testing of the unit.

FIG (5) :BLOCK DIAGRAM AM732AB (1 of 2) FOR BETA CHANNEL

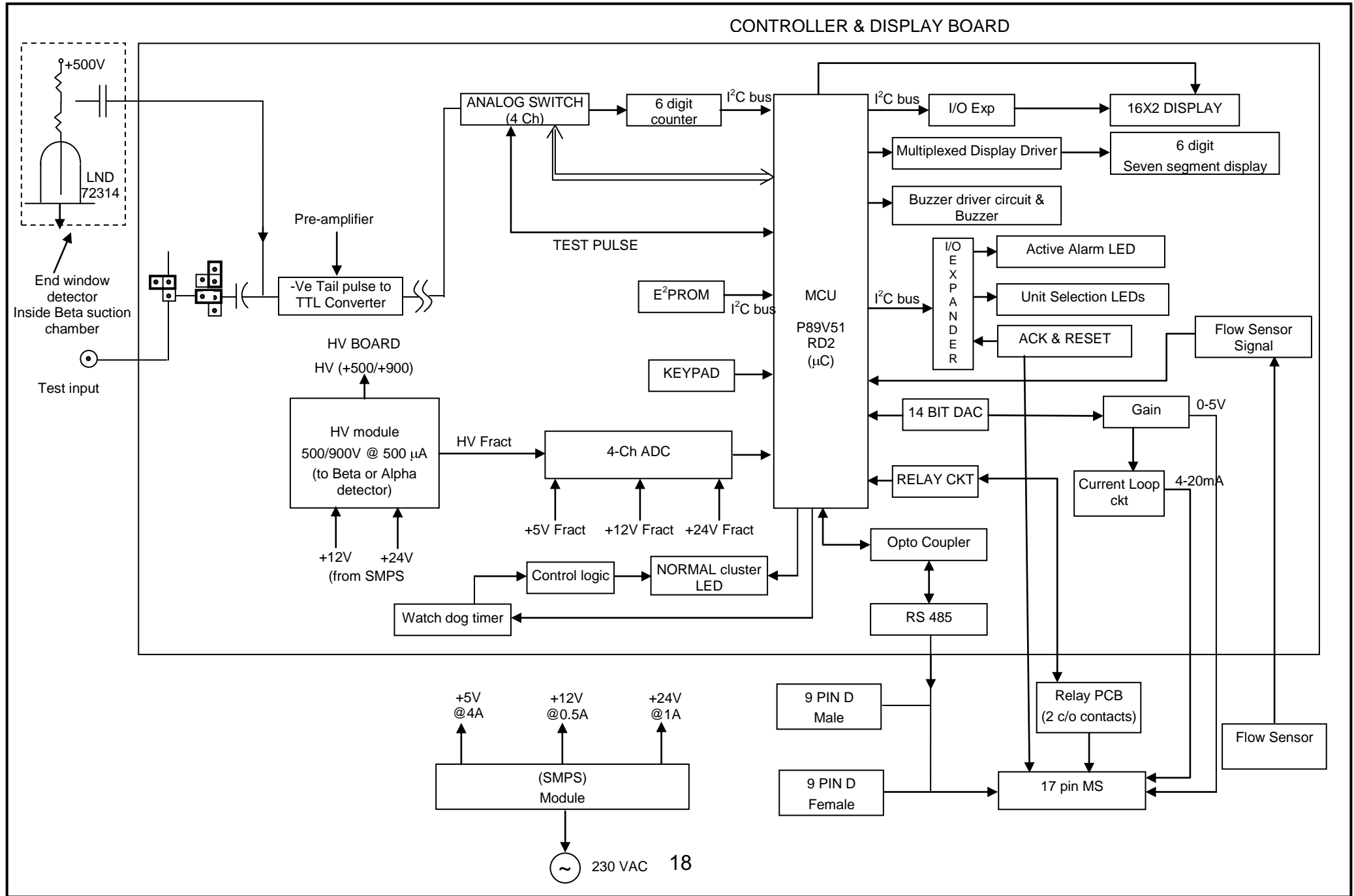
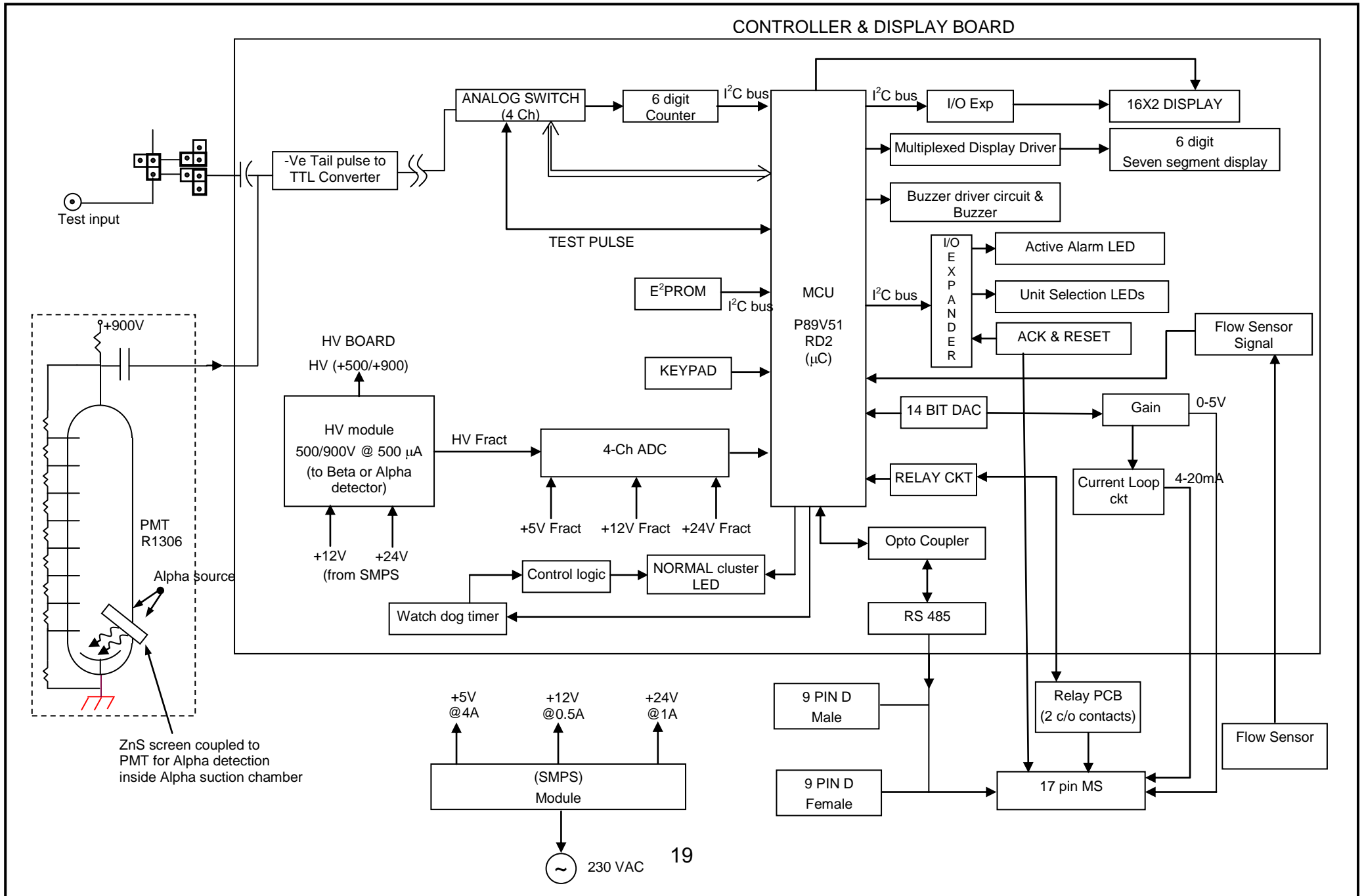

FIG (6) : BLOCK DIAGRAM AM732AB (2 of 2) FOR ALPHA CHANNEL



D ELECTRONIC MODULE INTERCONNECTIONS

The following table indicates system level inter connection details which include various connections between AC mains power source, to Rack, Electronic module (s) to suction chambers & I/O connector signals from modules to outside the rack etc.,

No.	Connection		Cable to be used
	From	To	
1.	"MAINS" 3 pin MS connector on Rear Panel	230V AC Mains socket	3 pin MS connector to standard mains connector
2.	Beta Electronic unit connector "BETA PROBE" MHV socket to Beta Sampling head.	Beta Detector assembly MHV socket	MHV to MHV cable
3.	Alpha Electronic unit connector "ALPHA PROBE" MHV socket to Alpha Sampling head.	Alpha Detector assembly MHV socket	MHV to MHV cable
4.	"EXT KEY PAD" 9 pin D-connector on front panel.	External hand held key pad.	5pin male I/O to 9 pin D-connector female connector.
5.	17 pin MS connector I/O connector from Alpha electronic module	Control room panel	17 core shield PVC cable
6.	17 pin MS connector I/O connector from Alpha electronic module	Control room panel	17 core shield PVC cable
7.	RS-485 port (female) of Alpha module	RS485 port (male) of Beta module	Twisted pair PTFE cable
8.	RS-485 port (male) of Beta module	RS485 input of Transio RS485 to RS232 convertor	Twisted pair PTFE cable

E WIRING DIAGRAMS DESCRIPTION: (Page No. 50, 51, 52 & 53) Wiring diagrams are distributed in FOUR pages First page covers most part of it. From page no. 50 it is seen that right from rear panel of electronics module that 230V, 50Hz AC power flows through ON/OFF toggle switch, in trans-absorbers PCB, connector J1, Fuse F1 (1.5A rated), Line filter, SMPS & into controller PCB @ J2. This SMPS provides +/- 24V, +/- 12V & +/-5V required for most of the circuits. +24V & +12V is additionally routed through J3 into HV module.

It can be noticed from the main wiring diagram that signals to 17 pin I/O connector are routed mainly through 25pin D-connector J1 & J4. TEST INPUTS from rear panel are also routed through D-25 pin (J1) connector. The other connections include RS485 signals into a pair of male/female 9 pin D-connectors, external keypad is interface through J2 & J9/P9. J2 is mounted on display PCB. Display PCB through J1 is interfaced to microcontroller PCB at J5/P5. Additionally ACK & RESET buttons are also wired into display PCB through J2.

This main wiring diagram also indicates pin out details of different connectors.

Wiring diagram on Page No. 51 indicates alpha detector (PMT based) & beta detector (GM detector based) signal inter connection details on to rear panel of electronic module. This diagram also indicates interconnection detectors between rear panel of electronic module & HV module.

The other details shown in this are 5 pin I/O connector for external keypad to 9 pin male D-connector on front panel of electronic module.

Next Page No. 52 indicates flow sensor wiring diagram using 3 pin MS connectors. Inter connection is from the sensors mounted on rotometer to rear panel of respective electronic modules.

Following Page No. 53 indicates power distribution wiring diagram. By referring to A.C power distribution wiring diagram, one can notice that A.C power source to (a) suction pump & (b) rest of the electronics are let in through two separate MS series three pin connectors.

Internal to the rack, there are three pin 16 amps power sockets (three for electronic modules) & one for suction pump, with ON/OFF switch arrangement.

Each of the electronic modules of AM732AB receives power separately from the reserved sockets provided inside the rack. There is one spare socket.

CHAPTER -V

OPERATING INSTRUCTIONS

5.1 CONFIGURATION AND OPERATION OF THE INSTRUMENT

INTRODUCTION: This chapter illustrates details on configuring and operating the instrument, for a desired installation in a plant environment. Basically, operating instructions are illustrated with the help of menu options / responses that appear on LCD / LED displays. Each of the menus facilitate the user to choose function/ value to be set or entered as desired for its operation, at the installed location. An external detachable keypad is used for programming the CAM for its functionality & operation.

Keypad in this case is detachable & is always in enabled condition. There are no additional jumpers, for selection. For disabling one has to disconnect the keypad cable.

An important note (to follow) for the user is

- ◀ / ▶ - “PROG” key can be used to enter in to the menu.
- ▲ - key can be used to increase the value at the cursor position / toggle the option.
- ▼ - key can be used to shift the cursor position from right to left / toggle the option.

Once all necessary interconnections are made as per the system interconnection table, the unit may be switched ON.

POWER ON CONDITION: When instrument is switched on, initially, the audio visual observations noticed till the indications shown are stable is called **power on condition**.

When the power is switched on, the following audio visual indications are noticed. First, to start with, one audio beep is heard. Followed by this the following visual indications will be lit. Red cluster LED window will flash for a while and goes off. Followed by this, normal cluster LED window will be lit, additionally other LED's for” dose rate unit” indication will all glow for a while and default selected unit LED will lit permanently. The status of LCD and large LED display with power on condition is given in the following table.

As soon as the unit is switched ON the below screen appears,

AIR ACTIVITY MONITOR	for 1 sec
NUCLEONIX SYSTEMS	for another 1 sec

By default unit goes into acquisition mode and displays the following.

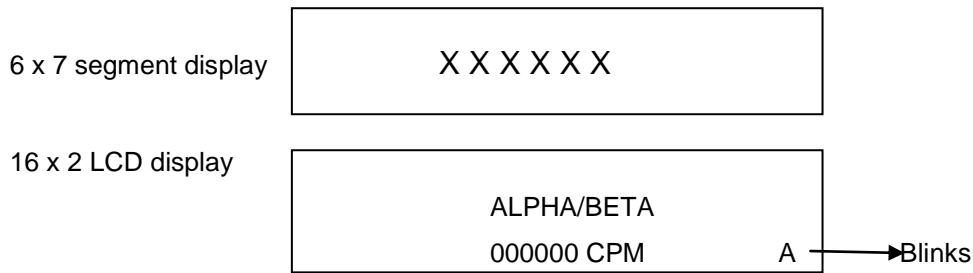

Now a blinking character 'A' appears indicating that unit is in acquisition mode and is calculating countrate.

The countrate in Alpha /Beta channels are refreshed on the seven segment display every 4 seconds.

Average countrate of last 4 measurements is written to alpha & beta channel 7-segment displays.

Now the unit can be configured through a detachable keypad.

Now on pressing 'PROG' key the display shows as below

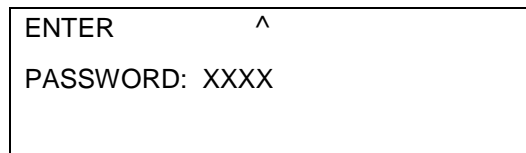

Now using ▲ or ▼ keys set password to "9090" for authorization to change program settings.

5.1.1 PRESET ALARM LEVEL

AM732AB will show the current default alarm set value of 50 CPM/. If user wants he can change to another value, by ▲ or ▼ keys.

Use PROG ► key to select below screen,

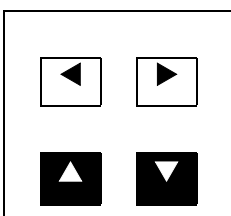
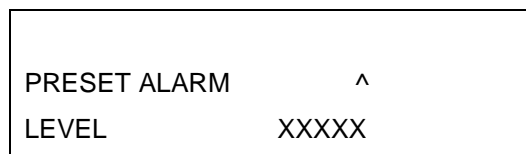
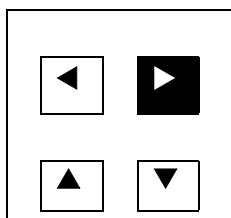

Now using ▲ & ▼ buttons set the preset level for alarms activation.

On pressing ▲, digit at location of the cursor is incremented by one unit rollover.

5.1.2 RESET MODE

'RESET' option user can either set it as AUTO or MANU (manual). In manual reset, user has to press the RESET button to bring back the unit into normal mode, once the dose rate falls below the alarm set point. In auto mode, once the dose rate falls below the alarm set point, the unit automatically returns to normal mode and the alarm condition is turned off. AUTO/MANU option can be selected by ▲ or ▼ keys. Default setting is = **Manual**

Select below option by using PROG ► keys

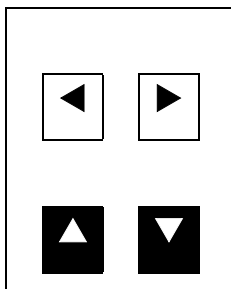
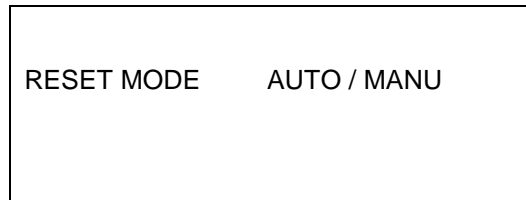
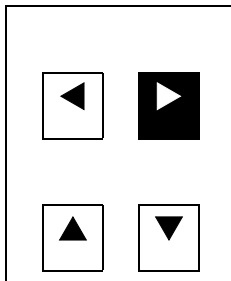

By pressing ▲ or ▼ keys we can select Reset mode as AUTO or MANU to reset alarms automatically or manually on user prompt after alarm levels fall below preset levels.

Once RESET MODE, option is selected user can now press 'PROG' button to go to next menu option i.e. 'Audio Status'

5.1.3 AUDIO STATUS

There are FOUR options, for the user and any one of the options can be selected by ▲ or ▼ keys.

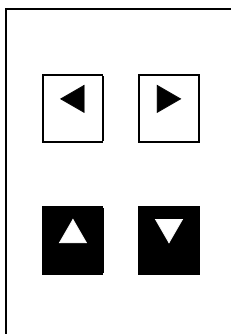
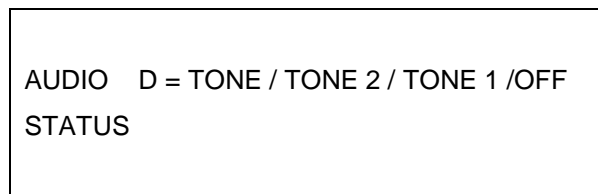
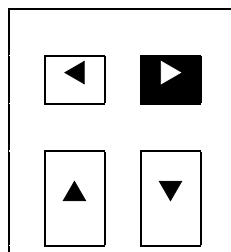

Now using ▲ or ▼ buttons it can be toggled as DUAL /TONE1/TONE2/OFF

These four options include dual tone, Tone2, Tone1 & off mode. Once this option is selected then press 'PROG' ► key to go to next menu option 'BAUD RATE'. Default setting is = **D TONE**.

5.1.4 BAUD RATE

Baud rate is to be selected for data communication in a networked environment for RS485 communication. There are two options as indicated in LCD display.

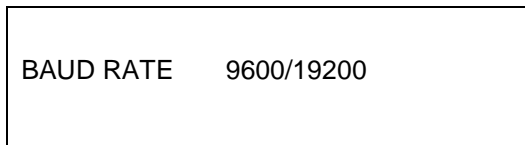

One can select any of the two options for baud rate by using by ▲ or ▼ keys. Having done that, user can go to next option by pressing 'PROG' key. The next option that appears in LCD display is hardware check. Default setting is = **9600**

5.1.5 HARDWARE CHECK

To perform hardware check, using PROG ◀ or PROG ▶ keys select below screen,

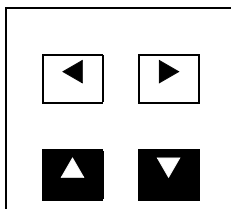
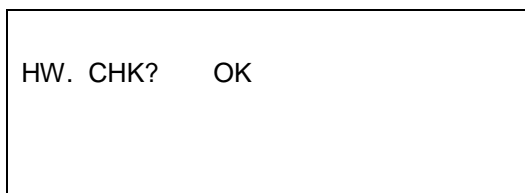
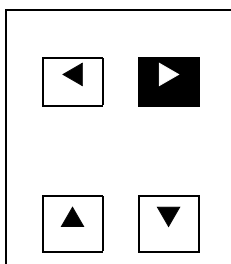

Now press ▲ or ▼ buttons to perform self- check.

Based on the various possible failure conditions appropriate messages are displayed as shown below.

No.	Conditions	Message on 7 segment Display
1.	HV is faulty	EHT
2.	+12V,+24V,+5V are faulty	LS_FL
3.	α Sensors failure or Pump failure	FL_FL
4.	β Sensors failure or Pump failure	FL_FL
5.	Zero α counts for more than 10 min	d_FL
6.	Zero β counts for more than 10 min	d_FL

5.1.6 DETECTOR EFFICIENCY

To view and the set Detector Efficiency, using PROG ◀ & PROG ▶ keys select below screen.

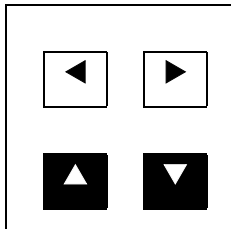
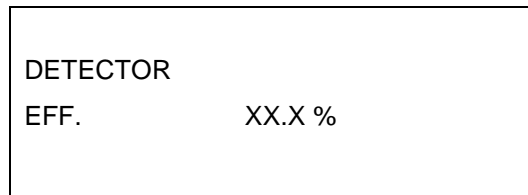
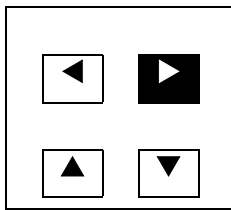

Now press ▲ & ▼ buttons to adjust the detector efficiency. This is required to display the measured value in terms of activity (Bq). By default it is set to 00.0% default. Having set this & upon pressing 'PROG' key, the next menu option that appears is SET UNIT.

5.1.7 SET UNIT (setting of engineering unit)

Here there are Three Units options that appear in the LCD display. The measuring units are CPS, CPM and Bq.

To view and modify the SET UNIT, using PROG ▶ keys select below screen,

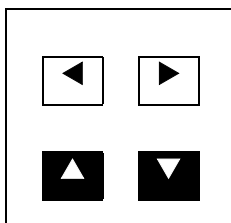
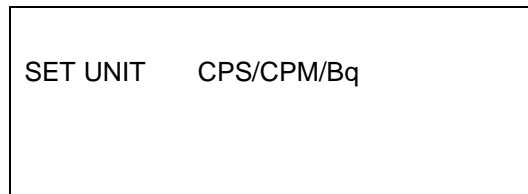
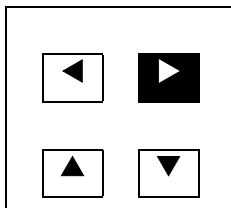

Now using ▲ or ▼ buttons, modify the SET UNIT to either CPS or CPM or Bq as needed.

5.1.8 DEVICE ADDRESS

This is a three character numerical value. This is RS485 address of the instrument limits 0 - 255

Default settings is = 000

To view and modify the DEVICE ADDRESS, using PROG ▶ keys select below screen,

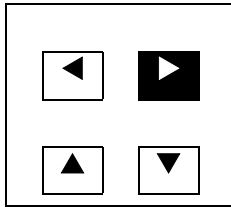

DEVICE XXX
ADDRESS

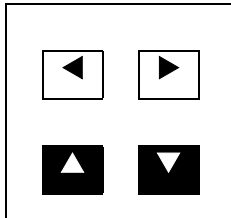

Use ▲ or ▼ keys to select the device/unit no. Default address is 000.
(This is used when multiple units are networked)

User can select desired three digit address (ID) of the instrument. Use ▲ or ▼ keys to load this value. Having completed this task press 'PROG' button for the next menu i.e., 'AUTO ACK'.

5.1.9 AUTO ACKNOWLEDGE

By ▲ or ▼ one can select or toggle this option. If it is selected as ON, after 5 minutes automatically alarm is acknowledged & audio alarm goes 'MUTE'. However visual alarm remains active. Default setting is = **OFF**.

To view and modify the AUTO ACK status, using PROG ► keys select below screen,

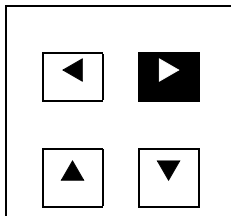

AUTO ACK OFF/ON
(5 min)

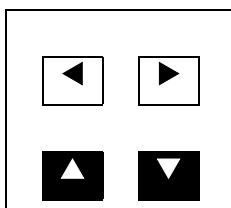

Use ▲ or ▼ keys to select the required mode. When AUTO ACK mode is ON, then the audio will get muted within 5 min of generation of alarm condition

The next menu option is 'MAX SCALE' which is prompted on pressing 'PROG' button.

5.1.10 CURRENT LOOP MAPPING

A. MAX. SCALE

Depending on the unit chosen i.e., CPS or CPM or Bq, the maximum permissible scales are 2,000, 50,000 and 50,000 respectively. User can choose any value upto a max of this upper limit & a value above the minimum value. Any value chosen out of these boundaries will be ignored, (at the time of saving settings) and default values will be loaded. In the display, chosen unit will appear & appropriate max value desired can be entered by the user. Similar is the case for other units such as CPS or Bq. After selection of max. scale, user can now select 'PROG' button to go to next menu option, as follows. Default setting is = **10,000CPM**.

MAX CPM
(4-20mA) XXXXX

To view and modify the CURRENT LOOP MAPPING (MAX. SCALE), using PROG ► keys select below screen,

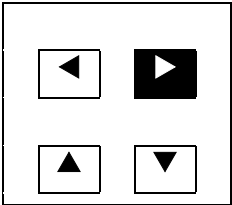

MAX. CPM ^
(4-20mA) XXXXX

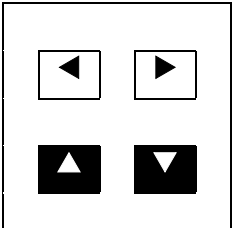

Use ▲ & ▼ keys to enter the MAX. count rate/ activity which corresponds 20mA current o/p.

B. MIN. SCALE

Depending on the scale selected initially, appropriate unit (i.e typical CPM) appears in the display. User cannot enter the min. scale value which is equal or above the max. scale value selected. Any value not meeting boundary conditions will be ignored while saving the settings & default value will be loaded. Similar if the engineering unit changed then the min. & max. scales are tabulated as follows,

MIN CPM
(4-20mA) XXXXX

Engineering Unit	Max. scale (4-20mA)	Min. scale (4-20mA)
CPS	2000	0000
CPM	50000	00000
Bq	50000	00000

To view and modify the CURRENT LOOP MAPPING (MIN. SCALE), using PROG ► keys select below screen,

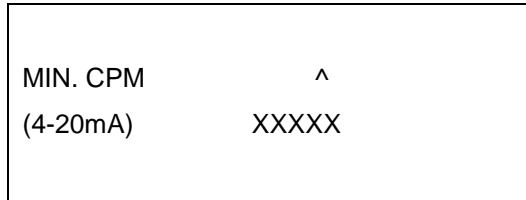
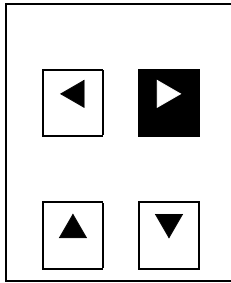

Use ▲ & ▼ keys to enter the MIN. count rate/ activity which corresponds to 4mA current o/p.

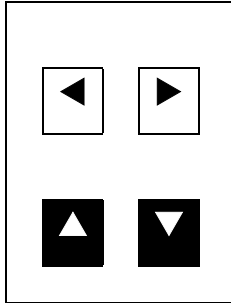

Followed by this, on pressing 'PROG' button, the following menu appears 'load default settings?'

Note : Max. & Min. scales are primarily for current loop scaling, for control room operation. Also, in the visual LED display also the same scales are set. Any value exceeding this max. scale will show as over range, as per definition in the LED display However in the lower LCD display it continues to show dose rate, as per actual value. Default setting for Min Scale is = **00000CPM**.

5.1.11 LOAD DEFAULT SETTINGS?

In case the user wants to retain default settings, he can skip all the previous menus & select this menu & chose option by pressing ▲ or ▼ key for default settings.

To load FACTORY DEFAULT SETTINGS, using PROG ◀ & PROG ▶ Keys select below screen,

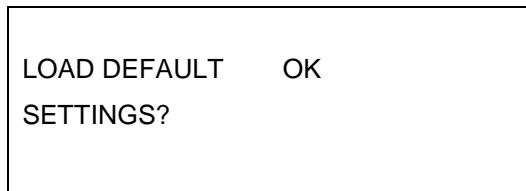
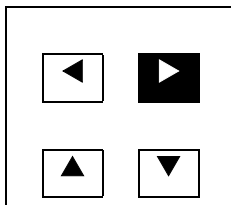

Use ▲ or ▼ key to load the default factory settings. OK message is displayed once the settings are updated

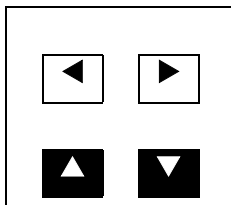

5.1.12 COUNTING CHANNEL SELECTION

Each Electronic module can be operated as an Alpha counting module or Beta counting module. For this, the EHT has to be adjusted as 500V for Beta and 900V for Alpha and the corresponding detector is to be connected. To select the corresponding channel adjusted, using PROG ◀ & PROG ▶ keys select below screen.

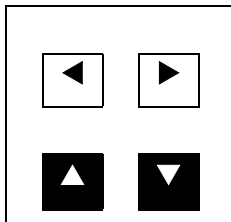
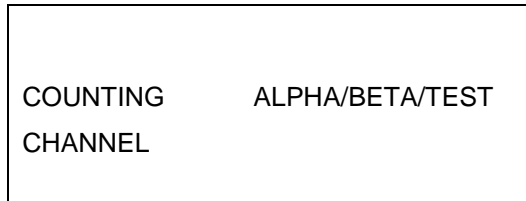
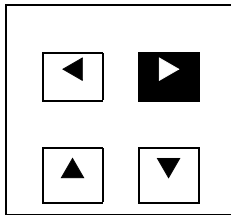

Use ▲ or ▼ keys, select the desired channel as ALPHA, BETA or TEST mode. In TEST mode, internal pulses are generated which are fed to the pulse processing electronics. This is independent of the Detector connected.

5.1.13 FLOW SENSE (Optical Sensing)

The suction pump draws flow in the range of 10-100lpm from each of the air samplers. Incase of any change in flow rate due to pump fault has to be sensed.

Optical source-detector sensing arrangement has been provided for sensing the flow rate through the Rota meters.

To modify the FLOW SENSE status, using PROG ▶ keys select below screen.

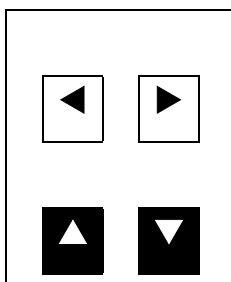
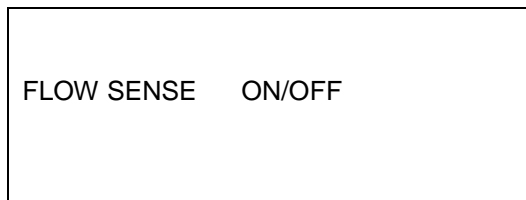
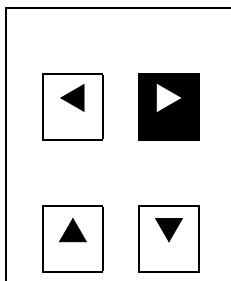

Use ▲ or ▼ keys, modify the FLOW SENSE status to either ON or OFF.

5.1.14 EHT: To view the EHT set for the corresponding detector channel, using PROG ◀ & PROG ▶ keys select below screen.

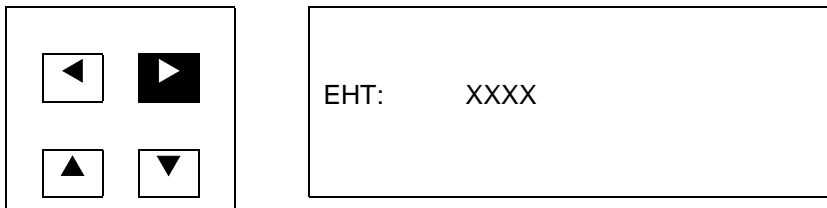

The currently set EHT to the corresponding detector is displayed on the LCD display. Normally for ALPHA we set 900v and for BETA we set 500v.

5.1.15 MODIFY PASSWORD

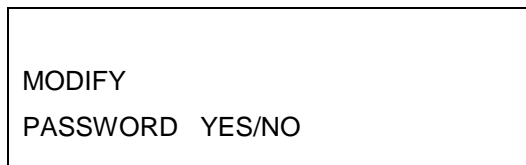

If user wants to change the pass word, he can do so by ▲ or ▼key. Select no option to retain same password. Having done that, finally we have completed all the 'PROG' button functions & are ready to save settings. The next menu that appear as given below.

5.1.16 SAVE SETTINGS

Use ▲ or ▼ keys to save all the above settings. These are permanently stored in the EEPROM and will be recalled at next powering on of the instrument. Having configured for required settings unit is now ready for operation, once settings are saved unit automatically gets into operation mode and starts acquiring Count rates and indicates in the display visually.

To save confabulated parameters in EEPROM, using PROG ▶ keys select below screen,

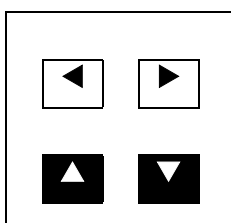

Now press ▲ or ▼ buttons to store the data into EEPROM. After data is stored OK appears on the screen. This indicates that the data has been stored

5.1.17 ACQUISTION MODE

The unit goes back to COUNT-RATE measurement mode within 15 seconds of last key press. The unit displays count-rate of the selected detector in CPS or CPM or Bq mode, depending upon the detector selected. The Time constant for the system is in the range of 4 seconds to 32 seconds inversely varying with respect to the count-rate.

CHAPTER – VI

AVAILING OF EQUIPMENT MAINTENANCE/ CALIBRATION SERVICES AND WARRANTY CLAUSE

6.1 GENERAL

As per the warranty clause of the company, we provide one year warranty during which period we provide free service at our works. Hence in case of any mal-function in our instruments, you are requested to send the unit back to our works by RPP/COURIER/SPEED POST PARCEL/GATI/XPS/door delivery. We shall arrange immediate rectification/replacement within two weeks from the date of receipt of the equipment at our place. Please note that the equipment will be serviced at our works only.

The equipment is to be sent to :

The Servicing Department

NUCLEONIX SYSTEMS PRIVATE LIMITED

Plot No: 162 A & B, PHASE II, I.D.A.Cherlapally,

Hyderabad - 500 051 Ph: 040-27263701/329145448/32918055

E-mail: info@nucleonix.com www.nucleonix.com

For all the Radiation monitoring equipment, detectors built-in or external probes will not have one-year warranty, but only inspection warranty at the time of supply is provided. Since detectors will / may have fragile glass construction, we do not provide warranty. In case of failure of these components, Nucleonix will supply detector replacement at cost-cost price.

Note: In respect of all types of portable radiation monitors, it may be necessary to checkup and **recalibrate the equipment once a year** at our works.

6.2 HOW TO AVAIL SERVICES FOR EQUIPMENT REPAIRS (DURING & AFTER WARRANTY)

6.2.1 DURING WARRANTY

The following procedure is to be followed by the customers with in India for availing services / repairing facility during warranty period.

- Customer must register service request / compliant with customer support department, Nucleonix.
- For all equipments, costing less than 3.0 lakhs or equipments weighting not more than 20Kg, one year warranty & free service is offered, when the equipments are sent to our works only.
- Equipment is to be properly packed with adequate cushion to prevent any damages in transit. Nucleonix Systems is not responsible for damages or loss during transportation.
- Packing / Freight charge is to be borne by customer when he sends the equipment to our works. However when we return after servicing packing will be Nucleonix responsibility & Freight charges will be to your account.

- please indicate in your correspondence equipment model & serial number.
- All the equipments are to be sent to our works only on door delivery basis.
- For Door Delivery Transportation contact XPS/GATI cargo in your city / town or a reliable courier service to pick the consignment from your place. For their nearest local address & phone no's look into their websites. Transit insurance if the customer feels is necessary it is to be covered.
- Nucleonix Systems will not receive the equipments sent by other modes of transportation, such as Rail/Road.
- After servicing equipments will be send back by same mode of transport such a XPS/GATI/COURIER/RPP.
- All types of Radiation detectors, glass ware, PMTs etc., which are fragile are not covered in warranty.
- You can also send the equipment personally to our works for repairs either during or after warranty, after fixing up with our service dept (Customer Support Division). If possible we may repair on same day or your person can stay for a day & get it repaired.

6.2.2 AFTER WARRANTY SERVICES

- On expiry of 1 year warranty, if you like to send the equipment (low cost less than 3.0 lakhs & smaller in size & weight less than 20 Kg) of repairs to our works, you may please follow the following procedure.
- Submit, Service request form given here, mentioning that you agree to pay service charges which includes: Basic service charges per unit / module are RS: 2000 + cost of components if it exceeds Rs:200 + packing charges (Rs:200) + Return Freight charges Rs:300 or actuals which ever is higher.
- Followed by this you can send the equipment straight away if it is within 5 years old. If the equipment is beyond 5 years old, then you can send it for repairs, only after you receive confirmation from Customer Support Division, that it is repairable & is not an obsolete model.
- For all equipments costing above Rs: 3.0 lakhs which are to be attended in the field only, you can obtain a quotation with relevant details by submitting service request form & avail the services accordingly.
- For all field servicing jobs, since we need to depute engineers, it is likely, to take time & also it will cost more which includes Engineer's TA & DA etc., apart from basic service charges + cot of spares etc. Please note that basic service charges will be different for different products depending upon sophistication.
- For all jobs to be serviced in the field, customer is requested to provide adequate details on the nature of problems, to enable our engineer to come prepared with adequate spares.

6.3 HOW TO AVAIL CALIBRATION SERVICES

- It is best advised that each of the Radiation monitors including Area monitors are calibrated once in a year. When you want to send your Radiation monitor / Area monitor / Contamination monitor for calibration to our works, you may submit "**Calibration Services request form**" & send the equipment for calibration, by following the steps given below:

- Send your equipment along with your work order, if it is 5 years old or less.
- Also send work order & clearly indicate that you will agree to pay calibration charges & also equipment repair charges additionally if the unit is faulty & requires repairs before one can take it up for calibration.
- You are requested to ensure good packing to avoid any transportation damages.
- Use only the specified following mode of transportation system for dispatching on door delivery basis. XPS/GATI cargo/Courier/RPP/Speed Post parcel etc., Send the equipment on freight paid basis. (Equipments sent by other methods such as Rail/Road etc., will not be collected.
- Immediately on receipt of the equipment, we will send an acknowledgement & also a proforma bill by email/post.
- Based on the proforma bill, once we receive the payment, equipment will be dispatched back b similar mode of transportation as mentioned above.3